

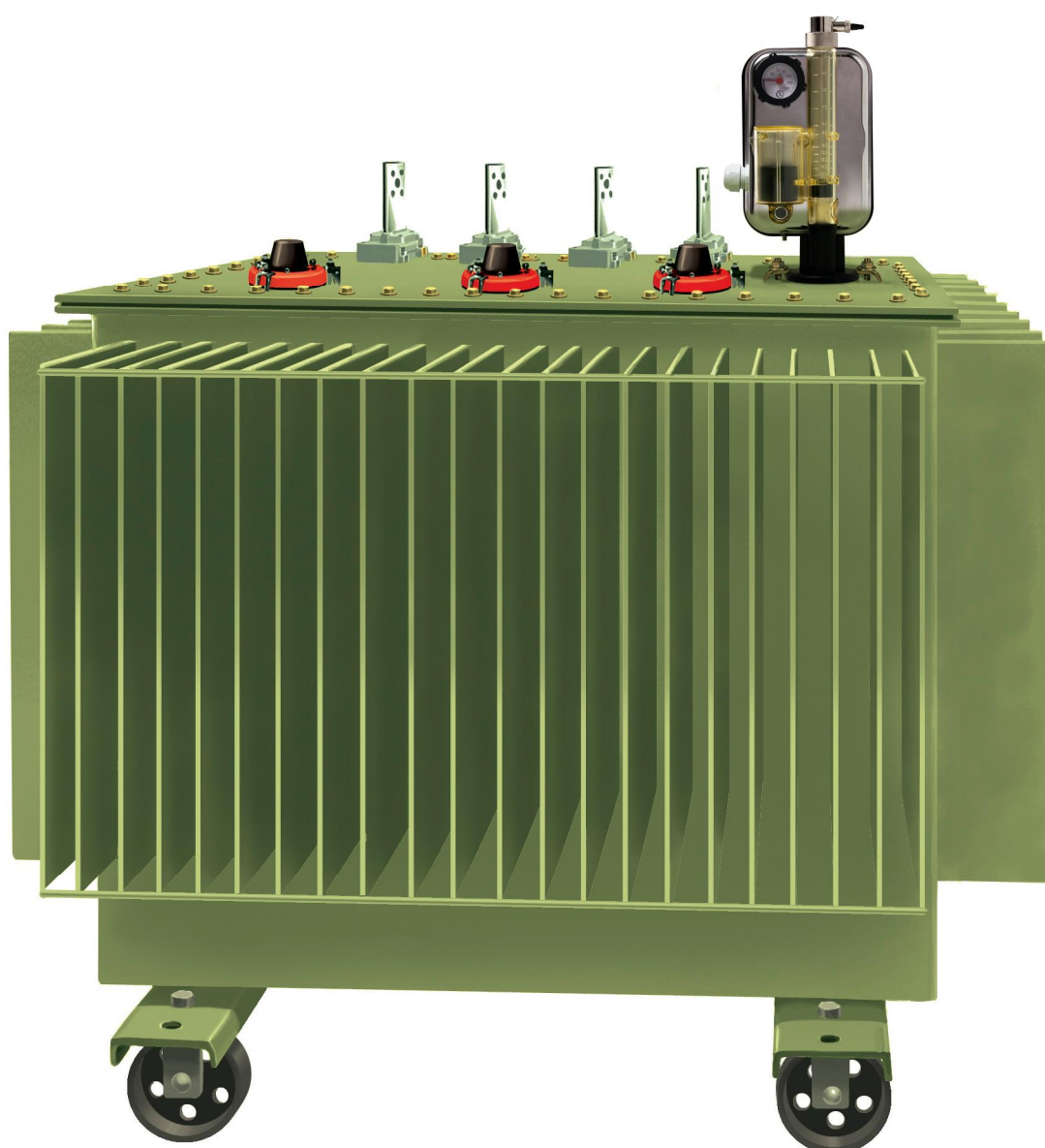

**TECHNICAL INSTRUCTIONS**  
**DGPT2®**



TECH. INSTRUCTIONS		Page	N° T/NOT-0021	Date: 11/01/12	Rev. 3
DGPT2®		1			



# 1- INSTALLATION (COMPLETELY FILLED HERMETIC TRANSFORMERS)

## 1.1 Preamble

The following installation procedure is given for information only. Automation 2000 cannot be held responsible for its execution.

## 1.2 Installation precautions

**Before installing the DGPT2<sup>®</sup>, make sure that:**

- The transformer is not powered.
- The transformer dielectric is at ambient temperature (approx. 20°C).
- The dielectric level inside the transformer is slightly below the transformer tank cover.
- The transformer opening on which the DGPT2<sup>®</sup> will be installed is opened.

## 1.3 Installation procedure

- Remove the drain tap and the level indicator float.
- Fit the Viton<sup>®</sup> seal (supplied) in the DGPT2<sup>®</sup> attachment flange throat.
- Mount the DGPT2<sup>®</sup> on the transformer opening designed for that purpose.
- Attach the fixing hooks (supplied) on the fixing bolts (3 at 120° or 4 at 90°) according to the tightening precautions (*see page 4*). The fixing bolts must be located on a circle with a 97 mm diameter ( $\pm 2$  mm).
- Fill the DGPT2<sup>®</sup> with transformer dielectric until its level reaches the DGPT2<sup>®</sup> highest point.
- Put back the level indicator float into place and close the DGPT2<sup>®</sup> with its drain tap.

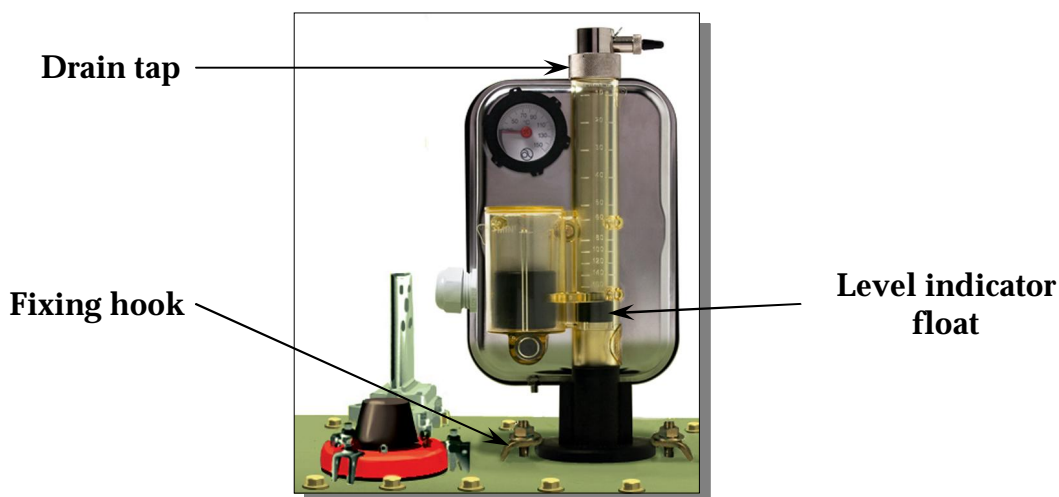

TECH. INSTRUCTIONS		Page	N° T/NOT-0021	Date: 11/01/12	Rev.
DGPT2 <sup>®</sup>		2			3



## 2- INSTALLATION (BREATHING TRANSFORMERS WITH CONSERVATOR)

### 2.1 Preamble

The following installation procedure is given for information only. Automation 2000 cannot be held responsible for its execution.

### 2.2 Installation precautions

**Before installing the DGPT2-IB, make sure that:**

- The transformer is not powered.
- The transformer dielectric is at ambient temperature (approx. 20°C).
- The transformer conservator is empty.
- The dielectric level inside the transformer is slightly below the transformer tank cover.
- The transformer opening on which the DGPT2-IB will be installed is opened.

### 2.3 Installation procedure

- Fit the Viton® seal (supplied) in the DGPT2-IB attachment flange throat.
- Mount the DGPT2-IB on the transformer opening designed for that purpose.
- Attach the fixing hooks (supplied) on the fixing bolts (3 at 120° or 4 at 90°) according to the tightening precautions (*see page 4*). The fixing bolts must be located on a circle with a 97 mm diameter ( $\pm 2$  mm).
- Connect the DGPT2-IB to the conservator through its IB insert with a flexible tube equipped with both a 3/8" female threaded end and a rotary fitting.
- Fill the conservator up to its normal level.
- Slowly open the DGPT2-IB sampling tap until the transformer dielectric level reaches the DGPT2-IB highest point and close it.

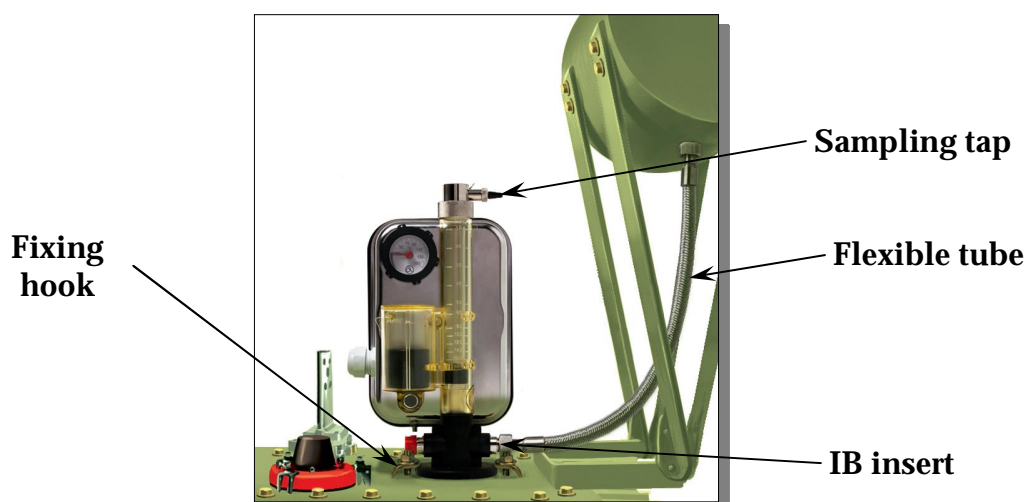

TECH. INSTRUCTIONS		Page	N° T/NOT-0021	Date: 11/01/12	Rev. 3
DGPT2®		3			



### TIGHTENING PRECAUTIONS

***When you tighten the HM8 bolts on the DGPT2® fixing hooks, make sure that:***

- ⇒ The tighten coupling is not higher than 3 m.kg (30 N.m).
- ⇒ The DGPT2® attachment flange DOES NOT TOUCH the transformer cover (the Viton® seal should stay visible – approx. 1 or 2 mm).
- ⇒ The DGPT2® fixing hooks are tightened one after the other, clockwise in two steps. During the first step, use a loose tighten coupling on all fixing hooks. During the second step, use a tighten coupling not higher than 3 m.kg (30 N.m).

### LEAKPROOFNESS PRECAUTIONS

***The DGPT2® drain tap's leakproofness is insured by a Viton® seal positioned at the root of the screw thread undercut.***

- ⇒ NEVER USE Teflon® tape (or similar tape) to insure the DGPT2® drain tap's leakproofness through its screw thread.

TECH. INSTRUCTIONS		Page	N° T/NOT-0021	Date: 11/01/12	Rev. 3
DGPT2®		4			



### 3- ELECTRICAL OPERATION

#### 3.1 Preamble

All DGPT2® monitoring functions come with change-over contacts (a Normally Opened contact, a Normally Closed contact and a Common point).

In the following diagrams, the contacts are shown unpowered (dead), meaning not under the influence of any defect for their respective monitoring functions.

#### 3.2 Operating diagram

##### 3.2.1 Gas discharge

Gas discharge is usually due to an electrical defect in the transformer active part, creating an electrical arc not strong enough to cause an instantaneous pressure increase.

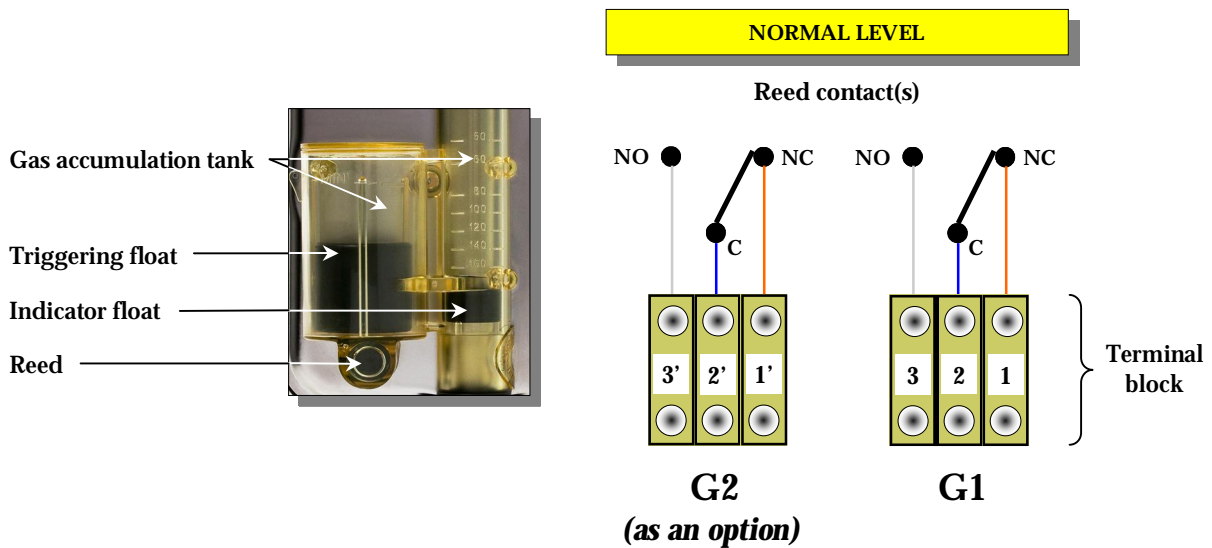

When the gas volume inside the gas accumulation tank reaches a certain value (depending on the dielectric density), the Reed contact changes position.

Dielectric density < 1    ⇒    Volume < 140 cm<sup>3</sup>

Dielectric density = 1    ⇒    Volume = 140 cm<sup>3</sup> (±5 cm<sup>3</sup>)

Dielectric density > 1    ⇒    Volume > 140 cm<sup>3</sup>

TECH. INSTRUCTIONS		Page	N° T/NOT-0021	Date: 11/01/12	Rev. 3
DGPT2®		5			



### 3.2.2 Excessive pressure

Excessive pressure is usually due to an internal short-circuit, creating an electrical arc strong enough to indirectly cause an instantaneous pressure increase.

Excessive pressure set-point is always defined by the transformer manufacturer.

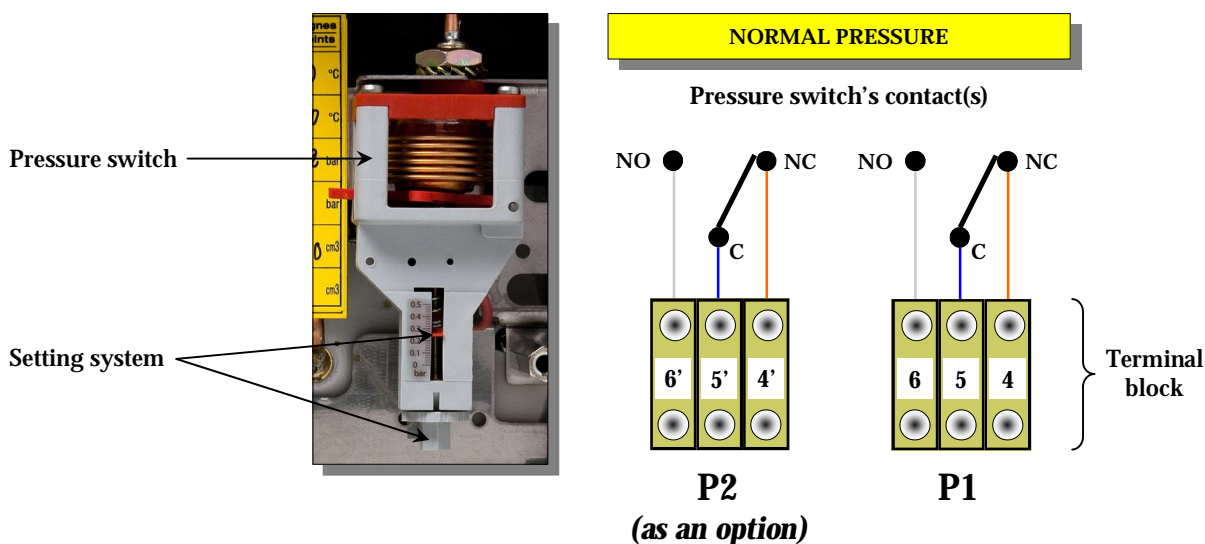

When the tank pressure reaches the set-point value ( $\pm 0.01$  bar), the pressure switch's contact changes position.

### 3.2.3 Temperature

Temperature elevation is usually due to an electrical defect inside the transformer tank causing a localized heating, or to an overcharge (an intensive transformer use above the operating conditions given by the transformer manufacturer).

Temperature set-points are always defined by the transformer manufacturer.

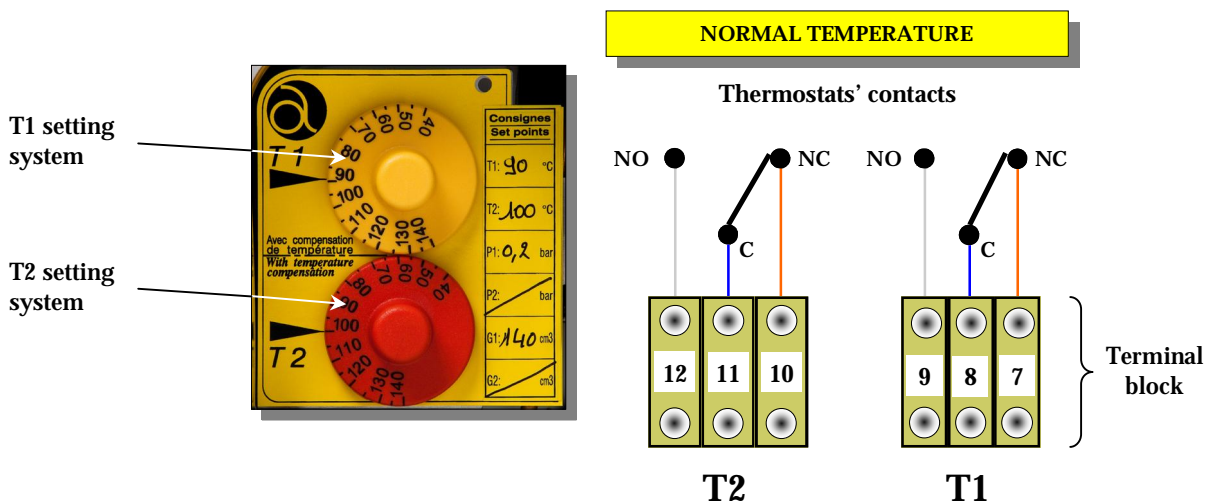

When the dielectric temperature reaches the set-point value ( $\pm 2.5^\circ\text{C}$ ), the thermostat's contact changes position.

TECH. INSTRUCTIONS		Page	N° T/NOT-0021	Date: 11/01/12	Rev. 3
DGPT2®		6			



## 4- TESTS

### 4.1 Precautions

**Before carrying out the tests, make sure:**

- That the transformer is not powered.
- To carefully check the wiring system.
- That the electric interlocking system is powered so that the loops can be tested up to the final element (e.g. LED for alarm function, actuators for trigger function).

### 4.2 Gas discharge

**Element concerned: Reed contact**

Moving a magnet (minimum Ø 22 mm, thickness 10 mm) under the Reed housing (or on the side) will change the contact's position.

Check that the loop is operating correctly.

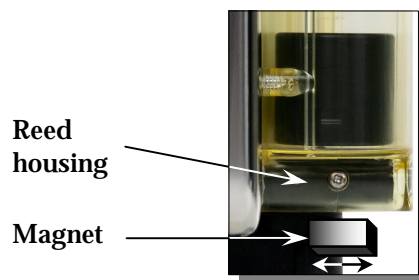

### 4.3 Excessive pressure

**Element concerned: Pressure switch type 1**

Press the test button located on the left side of the pressure switch.

The contact changes position.

Check that the loop is operating correctly, then release the test button.

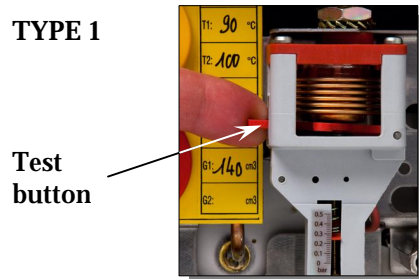

**Element concerned: Pressure switch type 2**

Turn the setting knob clockwise to bring the set-point to zero.

The contact changes position.

Check that the loop is operating correctly, then reset the set-point at the value indicated on the yellow identification plate.

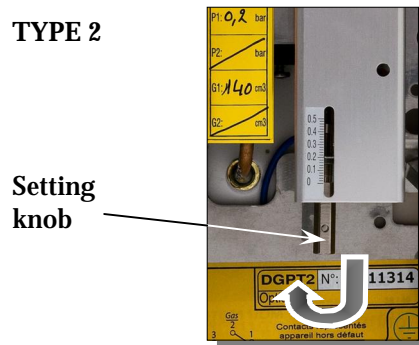

### 4.4 Temperature

**Elements concerned: T1 and T2 thermostats**

Turn the setting knob below its 40°C graduation.

The contact changes position.

Check that the loop is operating correctly, then reset the set-point at the value indicated on the yellow identification plate.

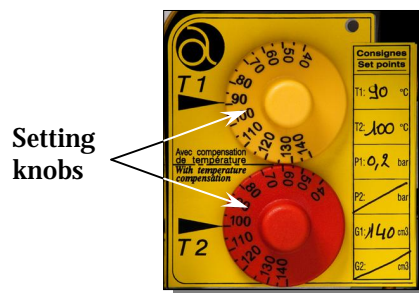

TECH. INSTRUCTIONS		Page	N° T/NOT-0021	Date: 11/01/12	Rev.
DGPT2®		7			3



## 5- CLEANING PRECAUTIONS

### 5.1 Basic precautions

DGPT2® plastic body is made of Trogamid® T5004, a transparent polyamide specifically treated against ultraviolet with an improved outdoor weathering behaviour.

When the DGPT2® plastic body needs to be cleaned, always make sure that the composition of the cleaning product (or leak detection product) does not contain any chemical listed on page 9. Diesel fuel and kerosene are excellent cleaning agents.

If you use a cleaning product containing one of these chemicals, cracks caused by the stress release inside the Trogamid® T5004 will appear on the DGPT2® plastic body. These stress-cracks will cause leaks and make the DGPT2® inoperative until its plastic body has been replaced.

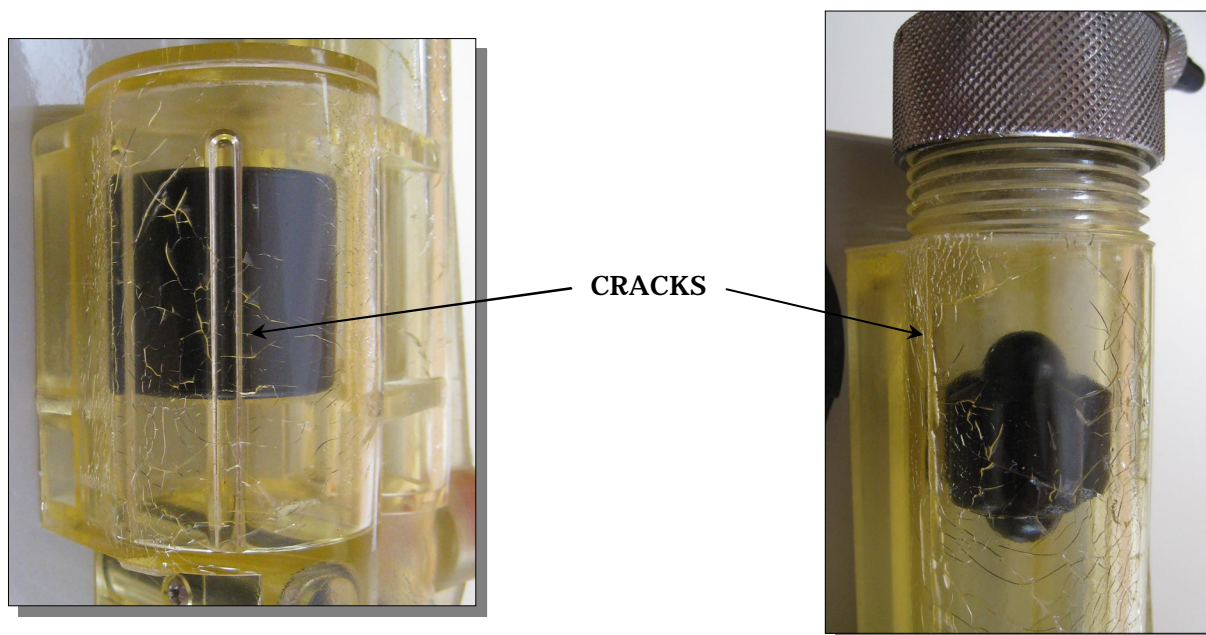

### 5.2 Loss of transparency

In contaminated atmosphere, successive layers of deposit can alter the DGPT2® plastic body transparency, and even totally occult the visibility of both the dielectric level and the floats.

In that case, the best way to recover partial visibility is:

- To use a cleaning product containing no chemical listed on page 9.
- To use an ultrafine plastic or painting polishing compound used for car body.

TECH. INSTRUCTIONS		Page	N° T/NOT-0021	Date: 11/01/12	Rev.
DGPT2®		8			3



**5.3 Chemical and solvent prohibited with Trogamid® T5004****A**

Acetone  
Acrylonitrile  
Allyl alcohol  
Ammonium sulfide, 40%  
Amyl alcohol  
Aniline

**B**

Benzaldehyde  
Benzoic acid\*  
Bromine, liquid  
1,3-butanediol  
1,4-butanediol  
2,3-butanediol  
n-butyl alcohol  
t-butyl alcohol  
Butylene glycol

**C**

Chloroform  
Chlorosulfuric acid  
Crotonaldehyde  
Cyclohexane

**D**

1,2-dichloroethane  
1,2-dichloroethylene  
Difluoromonochloromethane  
Dimethylformamide  
1,4-dioxane

**E**

Ethyl alcohol  
Ethylamine, 33%  
Ethylene diamine  
Ethylene glycol

**F**

Fluorodichloromethane  
Formic acid, concentrated  
Furfuralcohol

**G**

Gasoline (5% methanol)  
Glacial acetic acid

**H**

Hydrazine hydrate, 80%  
Hydrochloric acid, concentrated

**I**

Isoamyl alcohol  
Isopropanol

**M**

Methylene chloride  
Methyl ethyl ketone

**N**

Nitric acid, 2%  
Nitric acid, 10%  
Nitric acid, 30%

**P**

Potassium chlorate\*  
n-propanol  
Propylene glycol

**S**

Sulfuric acid, concentrated

**T**

Tartaric acid\*

*\* Saturated solution in water at 23°C*

TECH. INSTRUCTIONS		Page			
DGPT2®		9	N° T/NOT-0021	Date: 11/01/12	Rev. 3



## 6- TECHNICAL DATA

### 6.1 Metal housing

- Housing and cover in AISI 304 with 2 screws that can be sealed by lead

**Ratings:** IP56, IK07

- Wiring output through M25 cable gland with anchor (two positions possible)

**Tighten capacity:** 13-18 mm

- Wiring through terminal block with a 6 pitch

**Tighten capacity:** 4 mm<sup>2</sup> (12 or 18 terminals)

- 5 mm diameter earthing screw inside the housing

- 6 mm diameter earthing screw at the outside base of the housing

- Insulation: 500 VDC, 20 MΩ between terminals and earth

- Dielectric rigidity: 2,000 VAC, 1 minute between terminals and earth

- Fire hazard: the stuffing glands, terminal blocks, wires, etc. are made of self-extinguishing halogen free material. The housing contains fire.

### 6.2 Plastic body

- Plastic body in Trogamid® T5004 with ultraviolet stabilizer

**Ratings:** IP56, IK07

- Gas volume graduations in cm<sup>3</sup> (10-160 cm<sup>3</sup>)

### 6.3 Reed contact

- 1 Reed contact (2 Reed contacts as an option)

- Change-over contacts

- Measure accuracy: ±5 cm<sup>3</sup>

### 6.4 Pressure switch

- Metallic bellows with adjustable counterspring pressure switch with 1 microcontact (2 microcontacts as an option)

- Change-over contacts

- Adjustable set-point that can be sealed by lead

- Setting scale: 0-500 mbar (0-700 mbar on request)

- Setting accuracy: ±10 mbar

- Measure accuracy: ±5 mbar

- Response time: < 5 milliseconds

### 6.5 Thermostats

- 2 adjustable independent fluid expansion thermostats

- Ambient temperature compensation

- Change-over contacts

- Setting scale: 40-140°C

- Setting accuracy: ±2.5°C

- Measure accuracy: ±3°C at 60°C, ±1.5°C at 90°C

TECH. INSTRUCTIONS		Page	N° T/NOT-0021	Date: 11/01/12	Rev. 3
DGPT2®		10			



## 6.6 Thermometer

- 1 fluid expansion thermometer with tracking pointer access that can be sealed by lead

**Indicator diameter:** 50 mm

- Ambient temperature compensation
- Tracking pointer indicating maximum temperature reached
- Display scale: 40–150°C
- Reading accuracy:  $\pm 1^\circ\text{C}$
- Measure accuracy:  $\pm 4^\circ\text{C}$  at 60°C,  $\pm 1.5^\circ\text{C}$  at 90°C

## 6.7 Fitting

- Fitting at the base of the housing through a flange in composite with a thermowell to be installed on a 60 mm diameter opening (Viton® seal and fixing hooks supplied).

**Flange diameter:** 85 mm

**Thermowell:** 104 mm (length), 27-24 mm (diameter from top to bottom end)

- The flange and the thermowell do not conduct electricity.

## 6.8 Operating conditions

- Ambient temperature:  $-40^\circ\text{C}$  to  $65^\circ\text{C}$
- Dielectric temperature:  $\leq 140^\circ\text{C}$

## 6.9 Breaking capacity

Function	RESISTIVE LOAD - $L/R < 40\text{ ms}$				
	24 VDC	48 VDC	110 VDC	220 VDC	250 VAC 50/60 Hz $\text{Cos } \varphi 0.5$
Gas discharge	1 A	1 A	0.5 A	0.25 A	1 A
Excessive pressure	2 A	3 A	0.5 A	0.25 A	5 A
Temperature	4 A	4 A	1 A	0.5 A	8 A

## 6.10 Standard compliance

The DGPT2® conforms to the following Standards:

- IEC EN 50216-1
- IEC EN 50216-3
- IEC EN 60529
- NF EN 60439-1
- NF EN 60950
- NF C17-300
- NF C52-107

TECH. INSTRUCTIONS		Page	N° T/NOT-0021	Date: 11/01/12	Rev. 3
DGPT2®		11			



### 7- SPATIAL REQUIREMENT

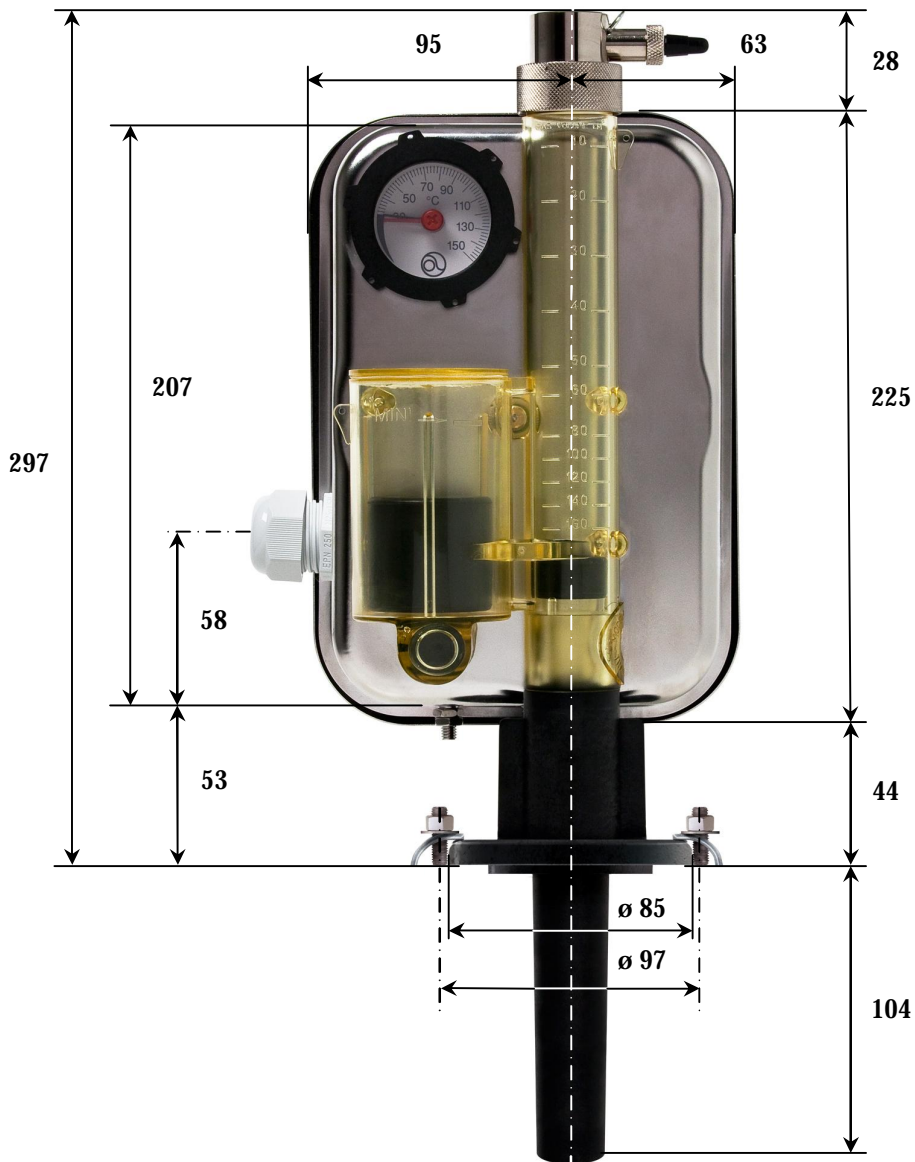
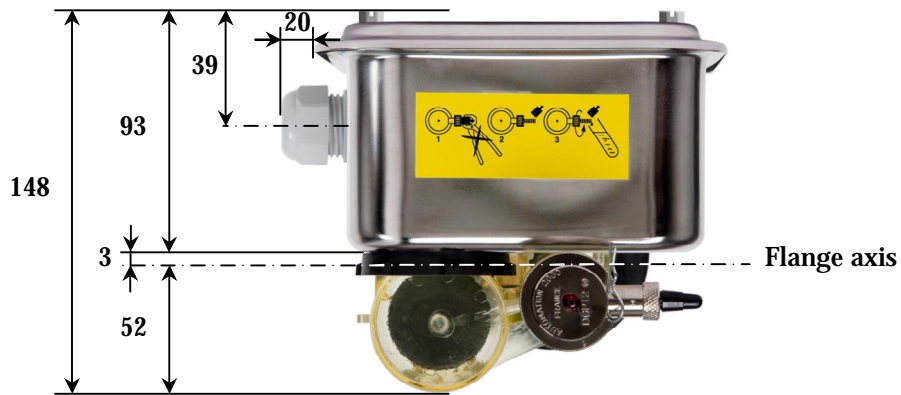

TECH. INSTRUCTIONS		Page	N° T/NOT-0021	Date: 11/01/12	Rev.
DGPT2®		12			3



## 8- OPTIONS

### 2G: 2 synchronous gas contacts

The DGPT2® is equipped with two Reed contacts, whose triggering thresholds are identical.

The Reed contacts' characteristics are identical to the Reed contact equipping the Standard DGPT2®.

Conforming to IEC EN 50216:3 Standard, the Reed contacts change position when the gas inside the transparent body reaches a volume between 100 and 200 cm<sup>3</sup>.

### 2GD: 2 gas contacts with an offset

The DGPT2® is equipped with two Reed contacts, whose triggering thresholds are offset by 40 cm<sup>3</sup> approximately.

Conforming to IEC EN 50216:3 Standard, the Reed contacts change position when the gas inside the transparent body reaches a volume between 100 and 200 cm<sup>3</sup>.

### 2P: 2 synchronous pressure contacts

The DGPT2® is equipped with a pressure switch with 2 microcontacts, whose triggering thresholds are identical.

The triggering threshold is defined by the customer.

### 2PD: 2 pressure contacts with an offset

The DGPT2® is equipped with a pressure switch with 2 microcontacts, whose triggering thresholds are offset.

Defined at the time of the order, this offset cannot be modified by the customer afterwards. It can never exceed 60 mbar.

The value indicated on the pressure switch's setting system is the lowest triggering threshold (P1).

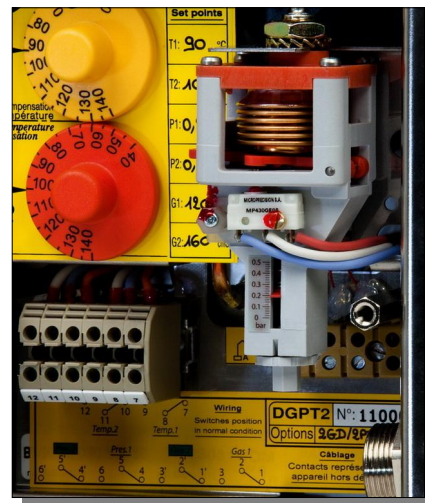

### CE: industrial connector

The DGPT2® is equipped with a Harting connector on the cover enabling the user to connect or disconnect the wiring system while the metal housing remains closed.



TECH. INSTRUCTIONS		Page	N° T/NOT-0021	Date: 11/01/12	Rev. 3
DGPT2®		13			



**FA: thermometer visible on the cover side**

The graduated dial of the thermometer is visible on the cover side of the metal housing.



**HT: high temperature body and flange**

The DGPT2® is equipped with a transparent body, a flange and a thermowell that can withstand a dielectric temperature up to 170°C.

**IB: connection for conservator**

The flange of this DGPT2® is equipped with two 3/8" male inserts for conservator connection (or connection to any other accessories).



**PA: marine cable gland**

The DGPT2® is equipped with a marine cable gland insuring the cable anchorage, the continuity of armour and the water tightness of both the internal and external cable coating from the connecting cable.



**PT: Pt100 sensor**

The DGPT2® is equipped with a Pt100 sensor (100 Ω at 0°C and 138.5 Ω at 100°C) located in the thermowell. It is connected to an independent terminal block with 3 or 4 wires depending on the customer's needs.



**SO: drain tap with popoff relief valve**

The drain tap equipping the DGPT2® includes a popoff relief valve.

Its calibration is defined by the customer and adjusted by Automation 2000.



TECH. INSTRUCTIONS		Page	N° T/NOT-0021	Date: 11/01/12	Rev. 3
DGPT2®		14			



**X: industrial and marine atmosphere**

The DGPT2® is equipped with a metal housing and cover made of AISI 316L stainless steel, a drain tap made of brass with chemical nickel coating, and fixing hooks made of AISI 316L stainless steel.

## 9- ACCESSORIES AND SPARE PARTS

### 1 Reed contact

Spare part for Standard DGPT2®.

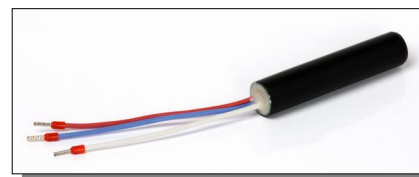

### 2 synchronous Reed contacts

Spare part for DGPT2® with option 2G.

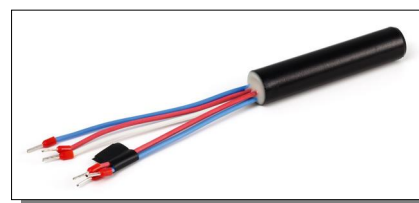

### 2 Reed contacts with an offset

Spare part for DGPT2® with option 2GD.

### 3/8" flexible tube for conservator fitting

This accessory consists of a corrugated hose made of AISI 316L stainless steel with a braiding made of AISI 304L stainless steel.

Its standard version is equipped with a 3/8" female threaded end and a rotary fitting made of AISI 316L stainless steel on both extremities.

The flexible tube's length is defined at the time of the order.



### Antimagnetic shield

This accessory has been designed to prevent spurious releases of the DGPT2®'s Reed contact in highly magnetic environments.

Made of AISI 430 ferromagnetic stainless steel, it is supplied with its fixing screw.



TECH. INSTRUCTIONS		Page	N° T/NOT-0021	Date: 11/01/12	Rev. 3
DGPT2®		15			



**Drain tap**

Spare part made of nickel plated brass.



**Drain tap with popoff relief valve**

Spare part made of nickel plated brass.

Its calibration is defined by the customer and adjusted by Automation 2000.



**Fixing hooks**

Spare parts made of steel or AISI 316L stainless steel.



**Flat seal for drain tap**

Spare part made of Viton® for drain tap with or without popoff relief valve.

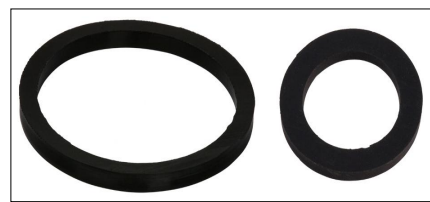

**Flat seal for flange**

Spare part made of Viton®.

TECH. INSTRUCTIONS		Page	N° T/NOT-0021	Date: 11/01/12	Rev. 3
DGPT2®		16			